

Poste de luz exterior dupla Farola "TOBIA" Fumagalli - CCT - 2 x 30W- 8 opções - E27

Ref. Q33.R20

Poste de iluminação Fumagalli "TOBIA" com difusor duplo de estilo clássico. Inclui 2 lâmpadas FUMAGALLI 30W CCT (3000K / 4000K). Fabricado em resina com tecnologia FumaTech®, garante a máxima durabilidade, resistência aos impactos, aos raios UV e à corrosão. Possui duplo isolamento Classe II e suporta altas temperaturas. Para uso residencial ou iluminação pública. Poste disponível em 4 opções de modelo e altura. Difusor disponível em acabamento opalino e transparente. **Compatível com lâmpadas E27 até 70W (não incluídas)**.







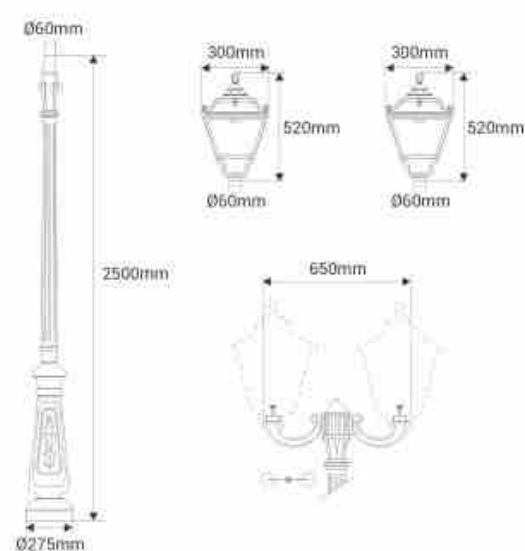

Dados do produto

Tonalidade	CCT
Kelvin (K)	3000, 4000
Lúmens (Lm)	3325lm (3000K) / 3620lm (4000K)
Potência (W)	60
Tensão Nominal (V)	220 - 240 V/AC
Casquilho	E27
Material	Resina
Material difusor	PMMA
IP	IP55
Certificados	CE, ROHS
Garantia	5 anos



Variantes do produto

Referência	Atributos	
Q33.202.R20.AYQ1K	Difusor - Opalino,Comprimento - 250cms	
Q33.205.R20.AYQ1K	Difusor - Opalino,Comprimento - 350 cm	
Q33.208.R20.AYQ1K	Difusor - Opalino,Comprimento - 400 cm	
Q33.238.R20.AYQ1K	Difusor - Opalino,Comprimento - 300 cm	
Q33.202.R20.AXQ1K	Difusor - Transparente,Comprimento - 250cms	
Q33.205.R20.AXQ1K	Difusor - Transparente,Comprimento - 350 cm	
Q33.208.R20.AXQ1K	Difusor - Transparente,Comprimento - 400 cm	
Q33.238.R20.AXQ1K	Difusor - Transparente,Comprimento - 300 cm	